

Name	Lillian TP 4x3 300x400_34		
Zeichnung/Drawing	3D	VS34_Lillian TP 4x3	
Profil/Profile	3.4x11.4	Maßstab/Scale	Druck auf/ Print on A4
			Datum/Date 18.02.2025

H = 1.700 m
 TOTAL: 10.20 m²

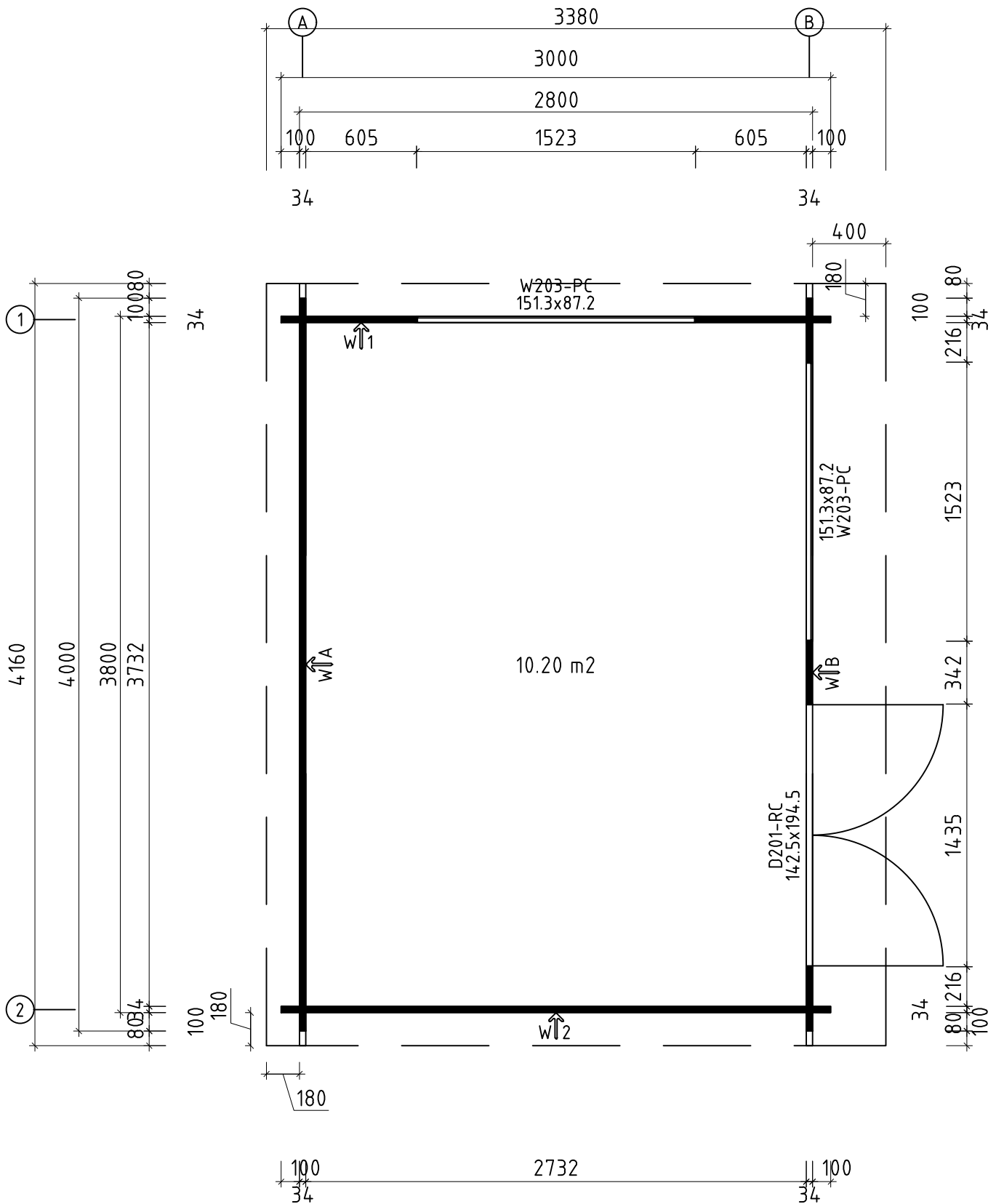



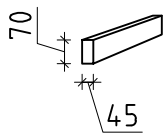
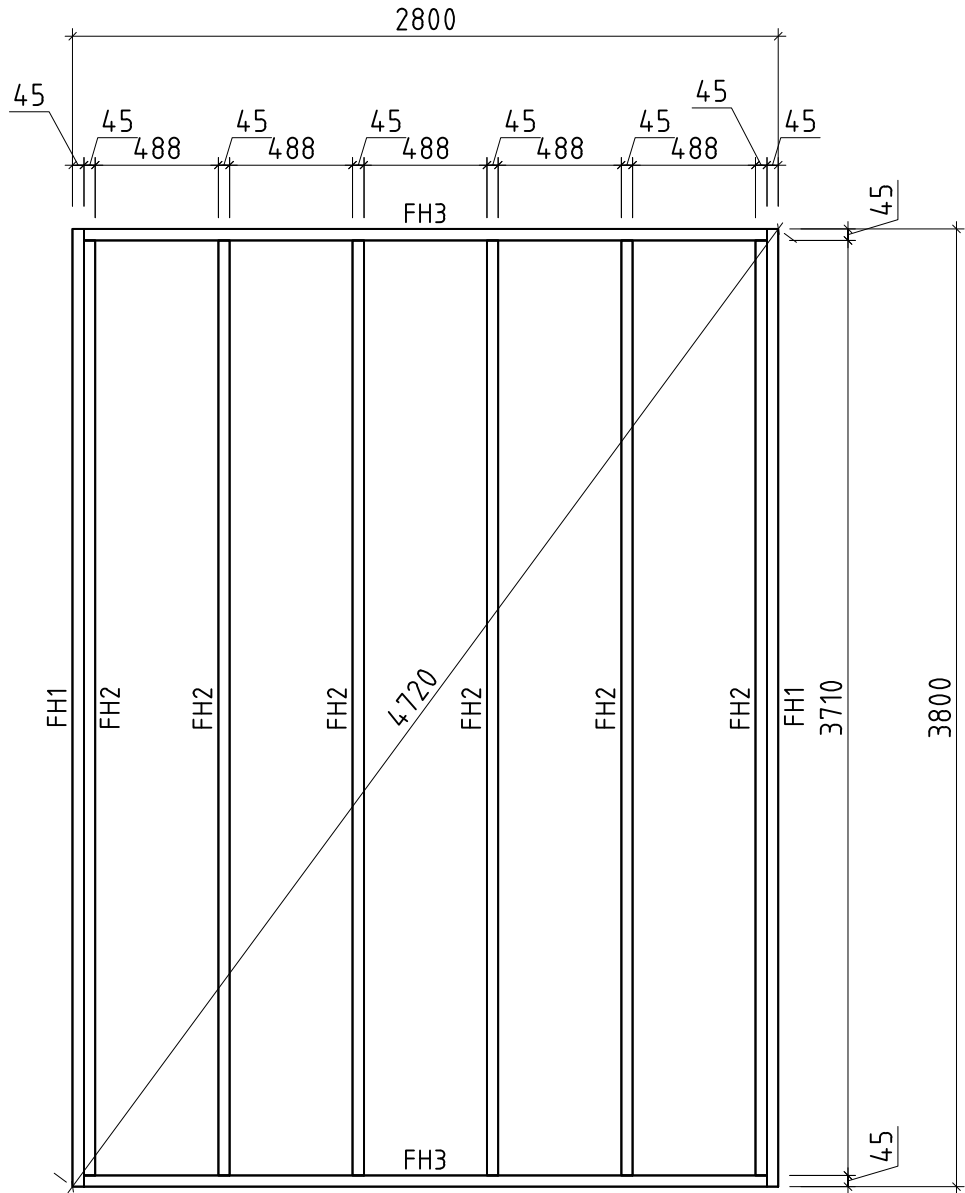

* Fenster und Türen sind mit Sprossen/
 Windows and doors are with muntins

Q3 - Qualitätsklasse für Fenster und Türen/
 Quality class for windows and doors

Name	Lillian TP 4x3 300x400_34		
Zeichnung/Drawing	Grundplan_Plan	VS34_Lillian TP 4x3	
Profil/Profile	3.4x11.4	Maßstab/Scale	1:30
Druck auf/Print on	A4	Datum/Date	18.02.2025

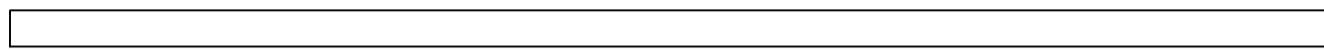
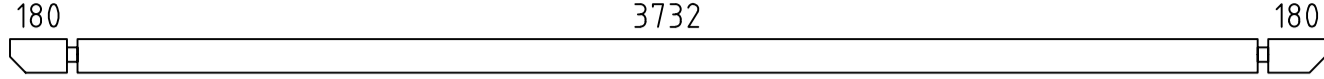
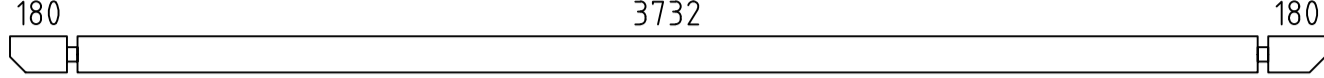
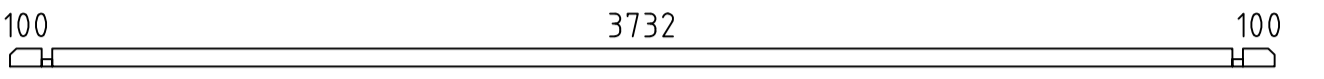
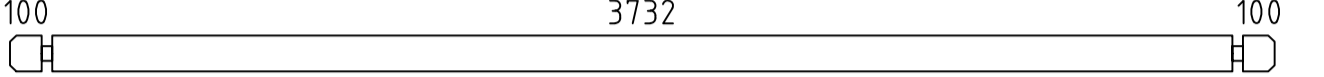
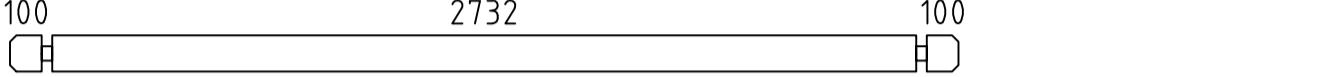
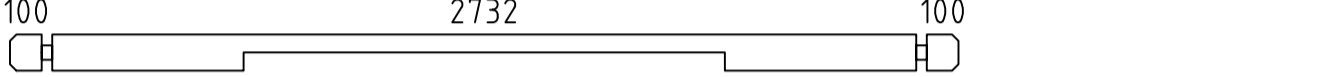
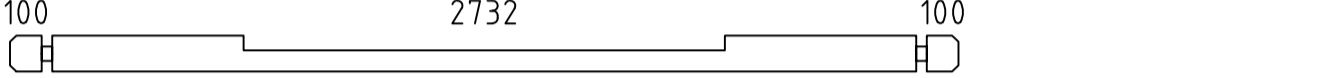
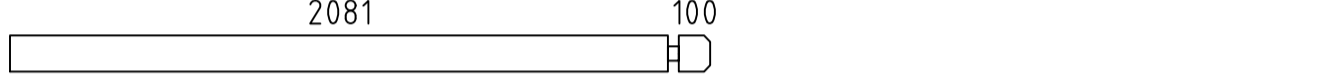
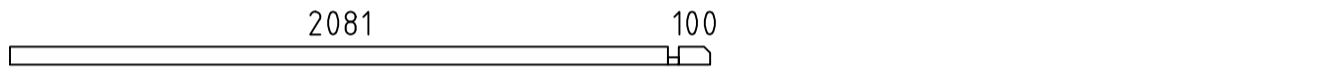



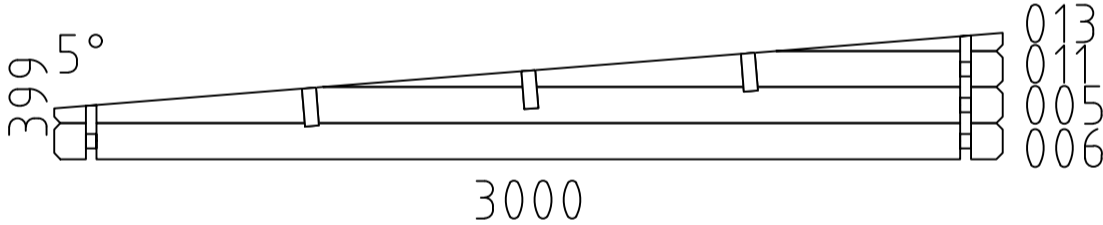
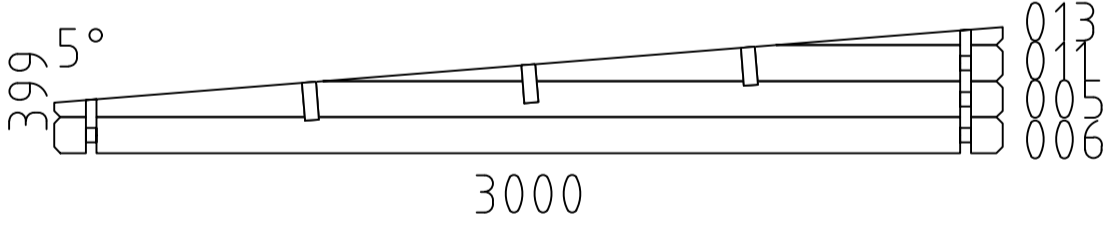
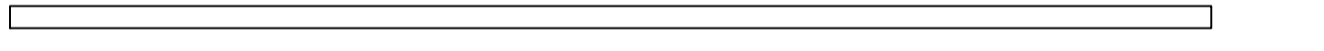
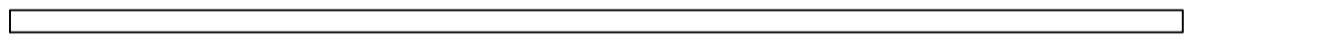
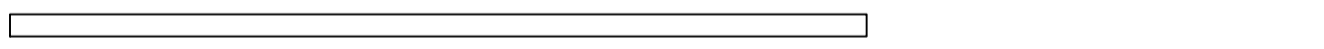
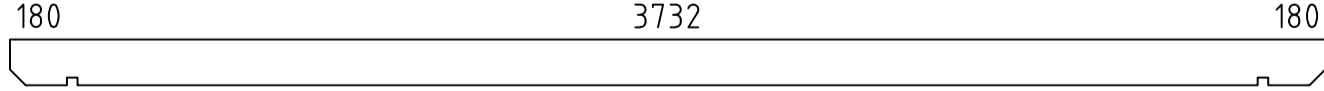
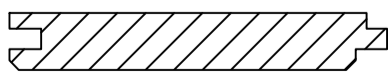
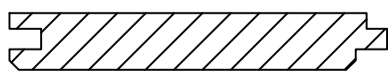
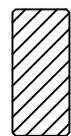

Name	Lillian TP 4x3 300x400_34		
Zeichnung/Drawing	Lagerholzplan_Foundation beams		YS34_Lillian TP 4x3
Profil/Profile	3.4x11.4	Maßstab/Scale	1:30
Druck auf/Print on	A4	Datum/Date	18.02.2025

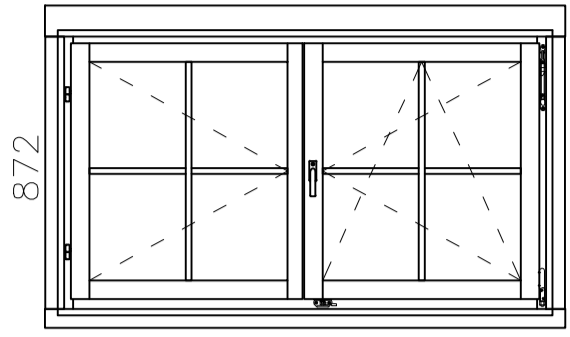
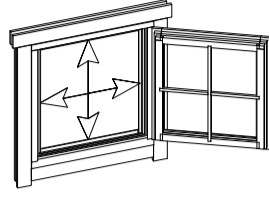
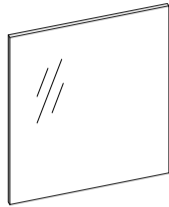
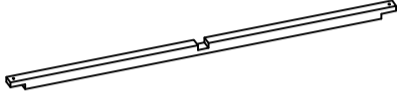
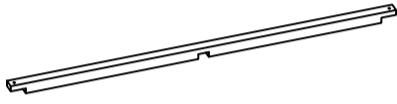
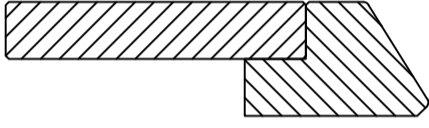
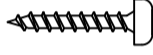
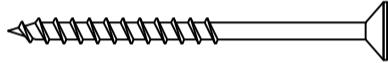
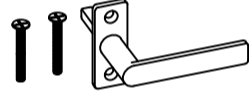
Pos	Teileliste/Specification Lillian TP 4x3 300x400_34	Stck Pcs.	Profil Profile (mm)	Länge Length (mm)
1extra		1	34x114	4160
001		1	34x106	4160
002		1	34x114	4160
003		1	34x57	4000
004		21	34x114	4000
006		27	34x114	3000
007		1	34x114	3000
008		1	34x114	3000
009		9	34x114	2215
010		1	34x57	2215
012		14	34x114	738
014		25	34x114	350
015		1	34x57	350
016		8	34x114	342
W1-1		1		
W2-1		1		
FH1	FUNDAMENTHOLZ (imprägniert) - FOUNDATION BEAM (impregnated) 	2	45x70	3800
FH2	FUNDAMENTHOLZ (imprägniert) - FOUNDATION BEAM (impregnated) 	6	45x70	3710
FH3	FUNDAMENTHOLZ (imprägniert) - FOUNDATION BEAM (impregnated) 	2	45x70	2710
PF1	PFETTEN - PURLINS 	3	44x145	4160
	DACHBRETTER - ROOF BOARDS 	37+1	113x18	3391
	FUSSBODENBRETTER - FLOOR BOARDS 	33+1	113x18	2727
	FUSSBODENLEISTEN - FLOOR STRIPS  ✓		18x40	14.0 lfm/rm
Kood	Lillian TP 4x3 300x400_34	Materjal		Leht 1/4

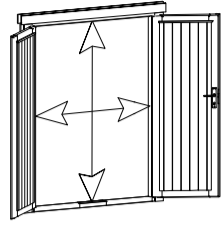
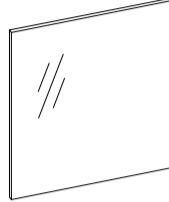
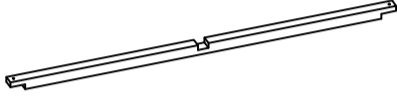
Pos	Teileliste/Specification Lillian TP 4x3 300x400_34		Stck Pcs.	Profil Profile (mm)	Länge Length (mm)
T02-1	TRAUFENBRETTER - EAVES BOARDS 18x120		2	18x120	3409
T01-1	TRAUFENBRETTER - EAVES BOARDS 18x95		1	18x95	4160
T01-2	TRAUFENBRETTER - EAVES BOARDS 18x95		1	18x95	4196
T04-1	TRAUFENDECKLEISTEN - EAVES COVER STRIPS 18x40		2	18x40	3409
T04-2	TRAUFENDECKLEISTEN - EAVES COVER STRIPS 18x40		1	18x40	4196
T06-1	TRAUFENLEISTEN - EAVES STRIPS 18x40			18x40	8.5 l/m/rm
SH	SCHLAGHÖLZER - MOUNTING PIECES		3		
NG2 550	NÄGEL - NAILS 2.5x50 Dachbretter - Roof boards		370		
NG2 550	NÄGEL - NAILS 2.5x50 Fussbodenbretter - Floor boards		396		
SR3 030	Schrauben - Screws 3.0x30 Fussbodenleisten - Floor strips		26		
SR3 030	Schrauben - Screws 3.0x30 Traufendeckleisten - Eaves cover strips		22		
SR3 030	Schrauben - Screws 3.0x30 Traufenleisten - Eaves strips		20		
SR3 545	Schrauben - Screws 3.5x45 Traufenbretter - Eaves boards		32		
SR5 0100	Schrauben - Screws 5.0x100 Fundamenthölzer - Foundation beams		40		
SS024	Schloßschrauben - Wood bolts M8x70 Mutter - Nut M8 U-Scheibe - Washer Ø25 (für Sturmleisten - storm reinforcement)		12		
	✓ - Bitte selber anpassen (falls nötig)! / Cut into length on site (if needed)!				
Kood	Lillian TP 4x3 300x400_34		Materjal		Leht 2/4

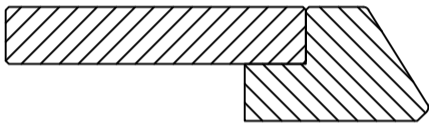
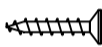
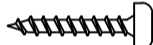
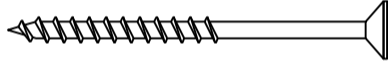
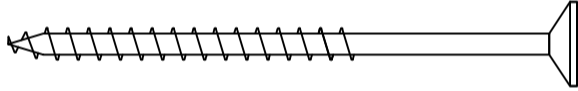
Pos	Teieliste/Specification Lillian TP 4x3 300x400_34		Stck Pcs.	Profil Profile (mm)	Länge Length (mm)	
	FENSTER/WINDOW 1513x872 W3-D34P-04C-15130872 Q3 W203-PC  <div style="display: flex; justify-content: space-between;"> <div style="border: 1px solid black; border-radius: 10px; padding: 5px;"> Right handed / DIN rechts / paremakäeline </div> <div style="border: 1px solid black; border-radius: 10px; padding: 5px;"> Clear opening/ durchgangsmaß/ ava suurus 1399x749mm  </div> </div> <div style="border: 1px solid black; border-radius: 10px; padding: 5px;"> double-pane clear float glass ISO Glas 2-fach 2x klaaspakett, kirkas klaas  </div>		2			
PROSS H1-1	Q2-Q3-1 Muntins - Sprossen - Prossid horizontal 18x18			4	18x18	654
PROSS V1-1	Q2-Q3-1 Muntins - Sprossen - Prossid vertical 18x18			4	18x18	712
WL-1	Rain strips - Wasserleisten - Vihmaliistud 36x134			2	36x134	1595
SR30 22-01	3.0x20ÜP Muntins - Sprossen - Prossid			16		
SR40 60-01	4.0x60 Rain strip - Wasserleiste - Vihmaliist			6		
AL-Q 2-Q3	Q2-Q3 Window handle - Fenstergriff - Aknalink			2		
Kood	Lillian TP 4x3 300x400_34		Materjal		Leht	3/4

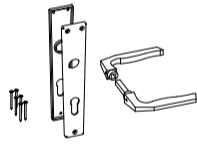
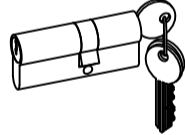
Pos	Teileliste/Specification Lillian TP 4x3 300x400_34	Stck Pcs.	Profil Profile (mm)	Länge Length (mm)	
	<p>TÜR/DOOR 1425x1945 D3-D34R-56C-14251945</p> <p>Q3 D201-RC 1425</p>  <div style="display: flex; justify-content: space-between; align-items: flex-start;"> <div style="border: 1px solid black; border-radius: 10px; padding: 5px; width: 150px;"> Right handed / DIN rechts / paremakäeline </div> <div style="border: 1px solid black; border-radius: 10px; padding: 5px; width: 150px;"> Clear opening/ durchgangsmaß/ ava suurus 1337x1857mm  </div> </div> <div style="border: 1px solid black; border-radius: 10px; padding: 5px; width: 150px; margin-top: 5px;"> double-pane clear float glass ISO Glas 2-fach 2x klaaspakett, kirkas klaas  </div>	1			
PROSS H1-2	Q2-Q3-1 Muntins - Sprossen - Prossid horizontal 18x18		4	18x18	517
PROSS V2-1	Q2-Q3-2 Muntins - Sprossen - Prossid vertical 18x18		2	18x18	975
WL-2	Rain strips - Wasserleisten - Vihmaliistud 36x134		1	36x134	1475
SR25 15-01	2.5x15 Locking plate - Schließblech - Riivi vastus 01 Q2-Q3		2		
SR30 22-01	3.0x20ÜP Muntins - Sprossen - Prossid		12		
SR40 60-01	4.0x60 Rain strip - Wasserleiste - Vihmaliist		4		
SR50 90-01	5.0x90 Door frames - Türrahmen - Ukselengid		8		
RV01	Locking plate - Schließblech - Riivi vastus 01 Q2-Q3		1		
UL-Q 2-Q3	Q2-Q3 Door handle - Türgriff - Ukselink		1		
LS-Q4	Q4 Cylinder lock - Zylinderschloss - Lukusüdamik		1		
Kood	Lillian TP 4x3 300x400_34	Materjal	Leht	4/4	

Vihmaliist / Rain strip / Wasserleiste

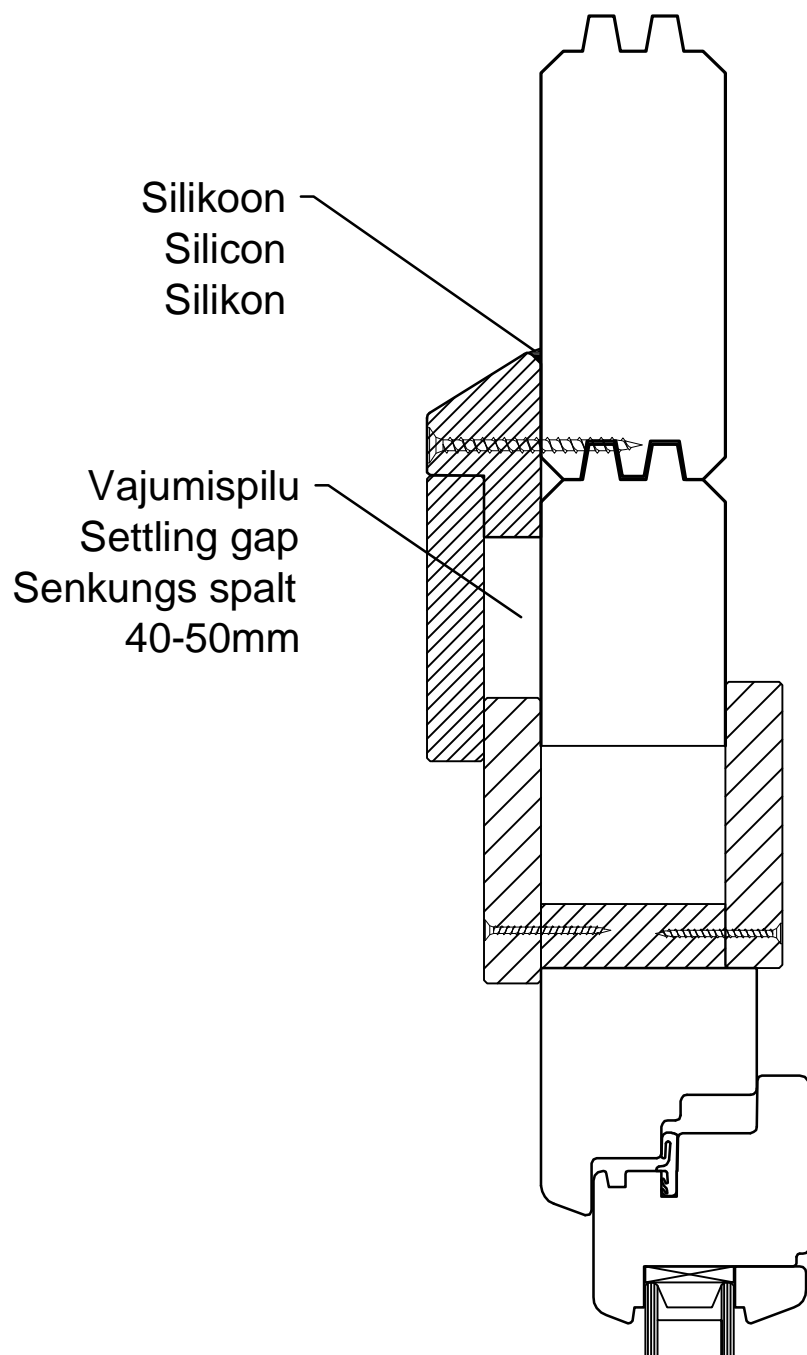

NB!

- Monteerida juhul kui ese on välja toodud maja spetsifikatsioonis!
- Install only if the item is listed in the house specification!
- Nur montieren wenn die Leiste in der Teileliste gezeigt ist!

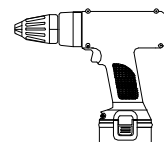

Uks	Q2-Q3	-	koostamisjuhhis
Door	Q2-Q3	-	assembly instructions
Tür	Q2-Q3	-	Montageanleitung

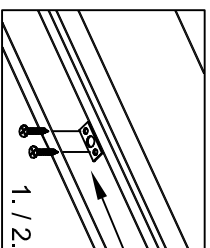
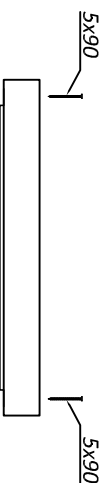

Ø8-10

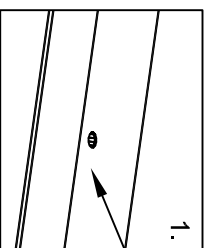
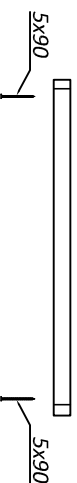
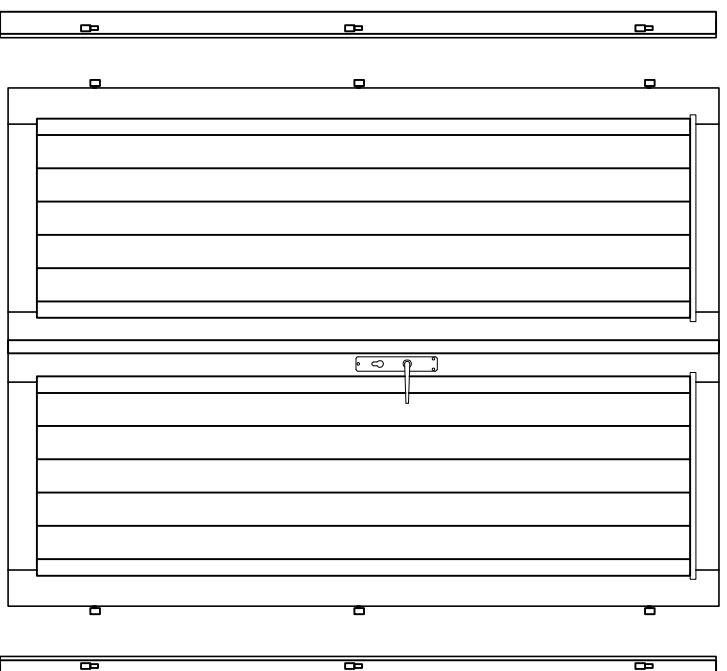
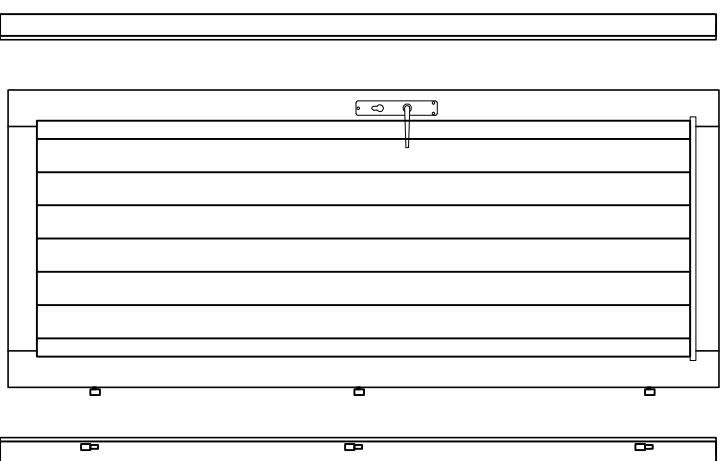
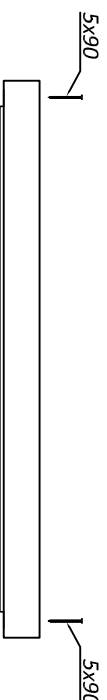

Ø8-10

*Kui ühepoolne uks ei ole kokku pandud!
 *When single door is not assembled!
 *Wenn Einzeltür ist nicht zusammengebaut!

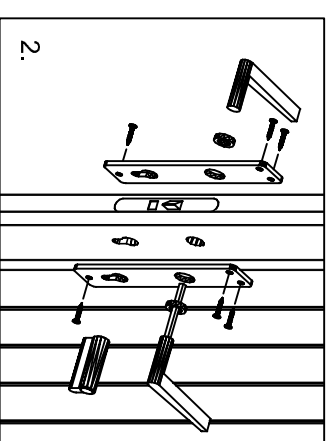
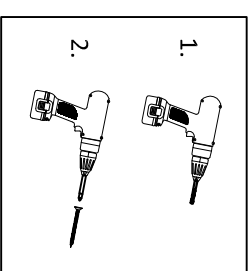

*Kui hinged ei ole paigaldatud!
 *When hinges are not attached!
 *Wenn Scharniere sind nicht angebracht!

Rain strip / Wasserleiste / Vihmaliist

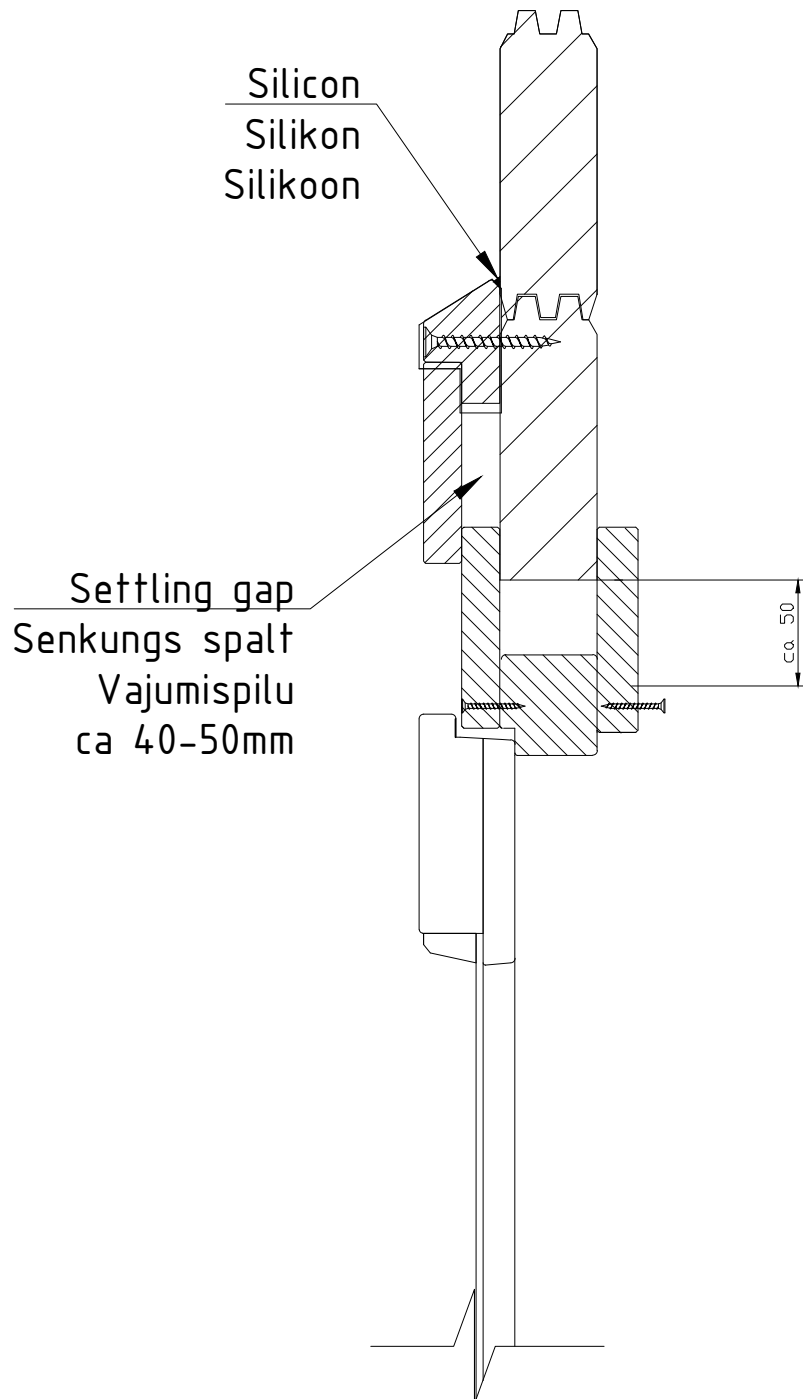

NB!

- Install only if the item is listed in the house specification!
- Nur montieren wenn die Leiste in der Teileliste gezeigt ist!
- Monteerida juhul, kui liist on välja toodud maja spetsifikatsioonis!

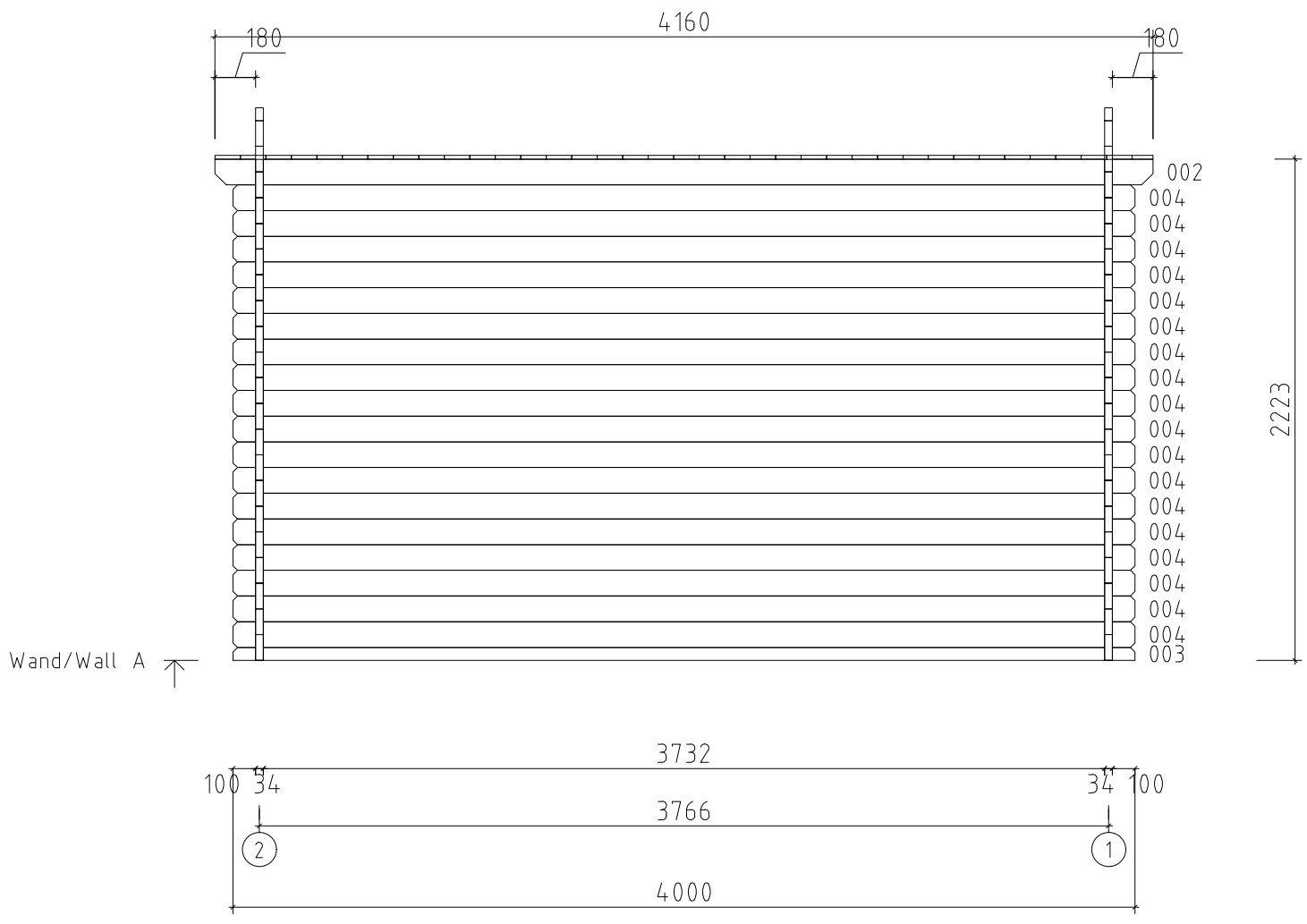

Name				Lillian TP 4x3 300x400_34			
Zeichnung/Drawing		WAND/WALL A		VS34_Lillian TP 4x3			
Profil/Profile		3.4x11.4		Maßstab/Scale		1:30	
		Druck auf/Print on		A4		Datum/Date	
						18.02.2025	

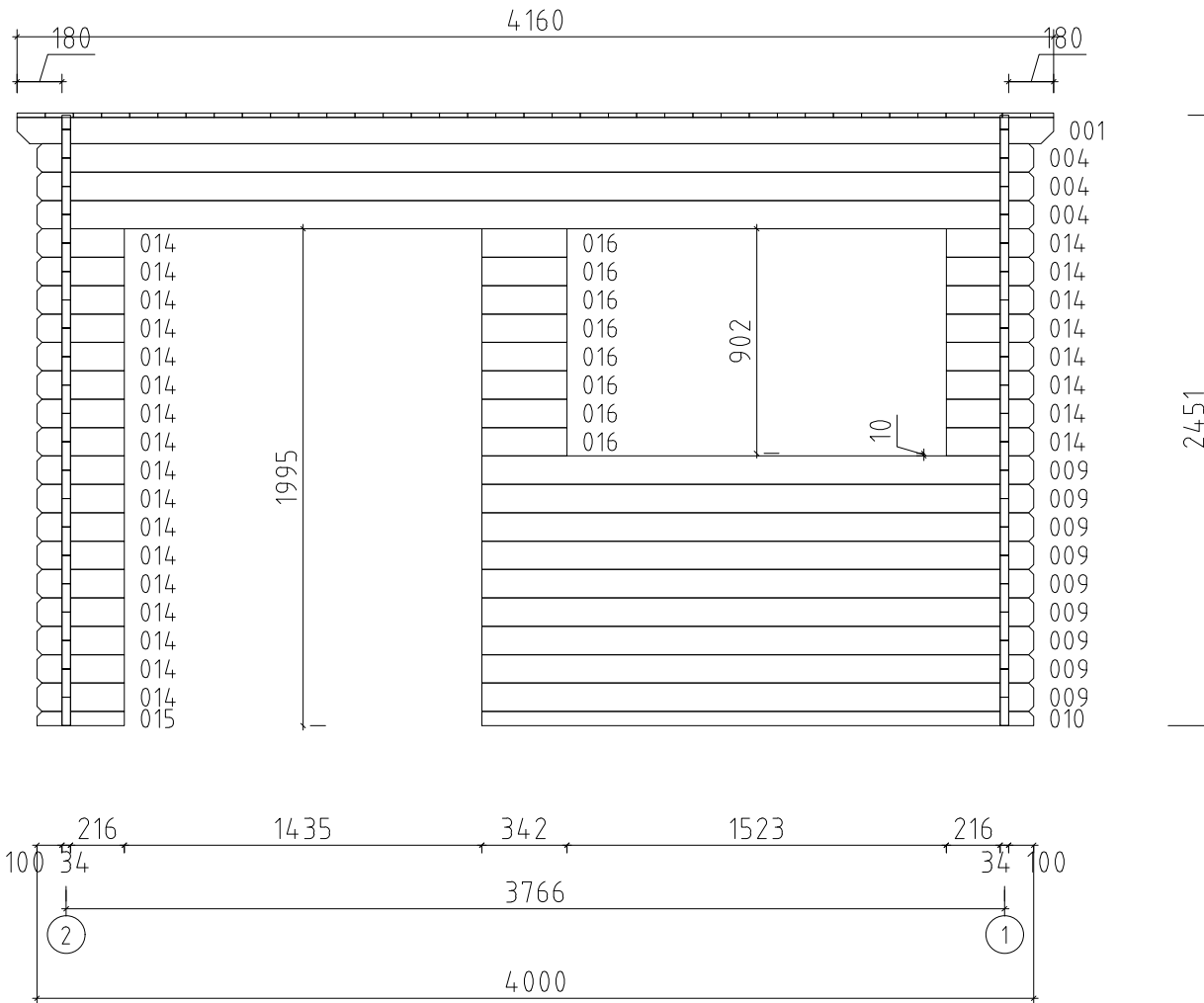
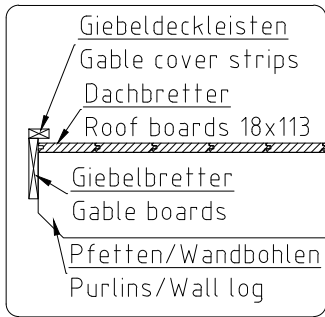

Wand/Wall B ↗

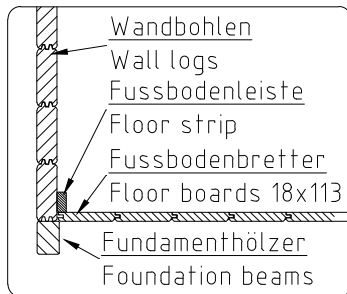

Name	Lillian TP 4x3 300x400_34		
Zeichnung/Drawing	WAND/WALL B	VS34_Lillian TP 4x3	
Profil/Profile	3.4x11.4	Maßstab/Scale	1:30
		Druck auf/Print on	A4
		Datum/Date	18.02.2025

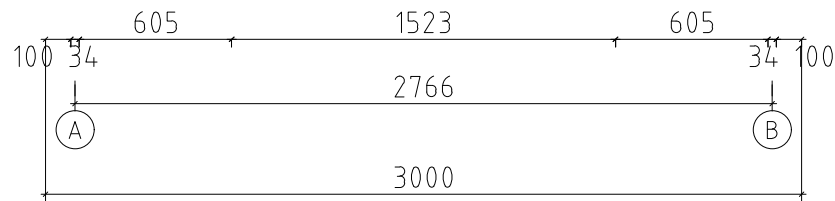
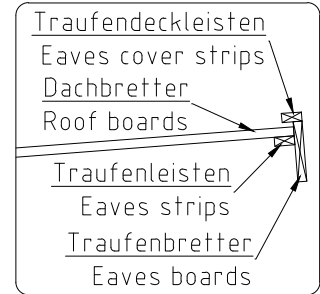
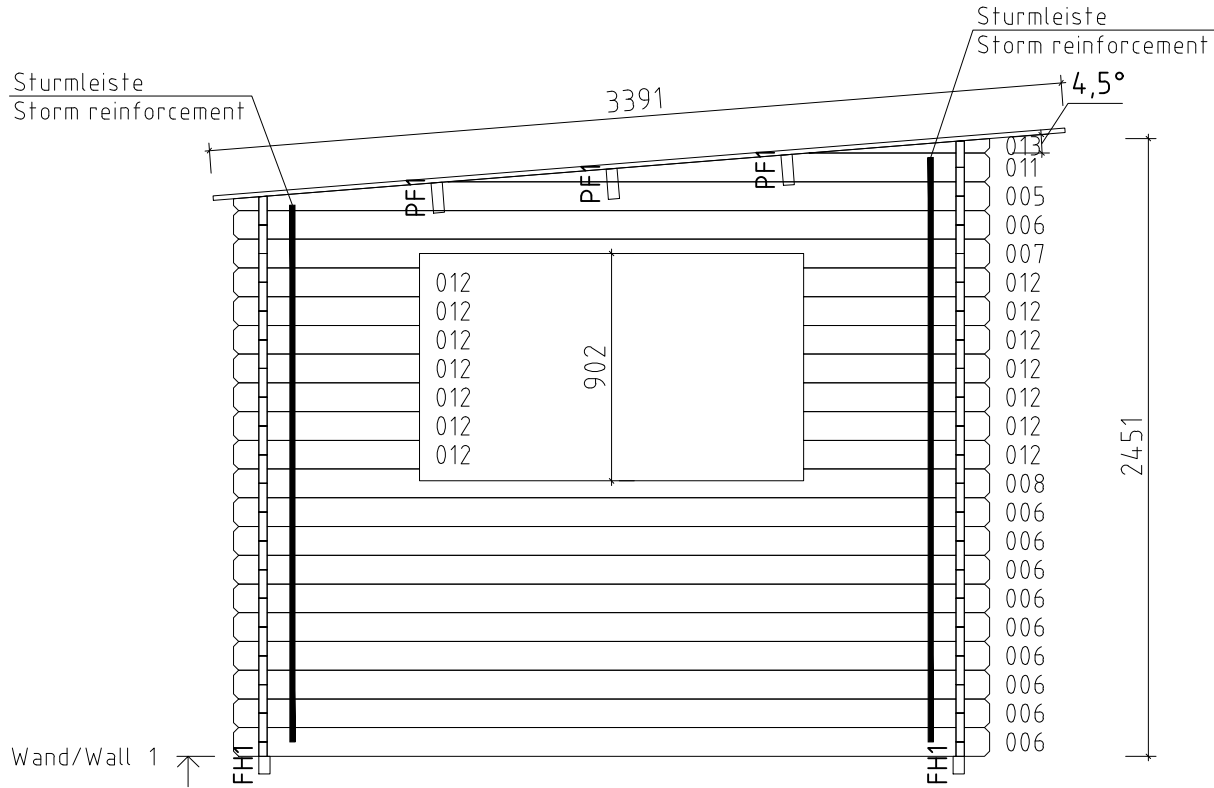
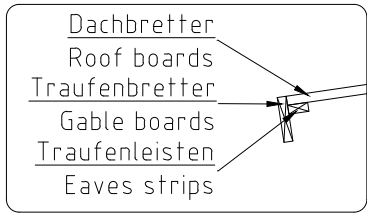

Name	Lillian TP 4x3 300x400_34		
Zeichnung/Drawing	WAND/WALL 1	VS34_Lillian TP 4x3	
Profil/Profile	3.4x11.4	Maßstab/Scale	1:30
Druck auf/Print on	A4	Datum/Date	18.02.2025

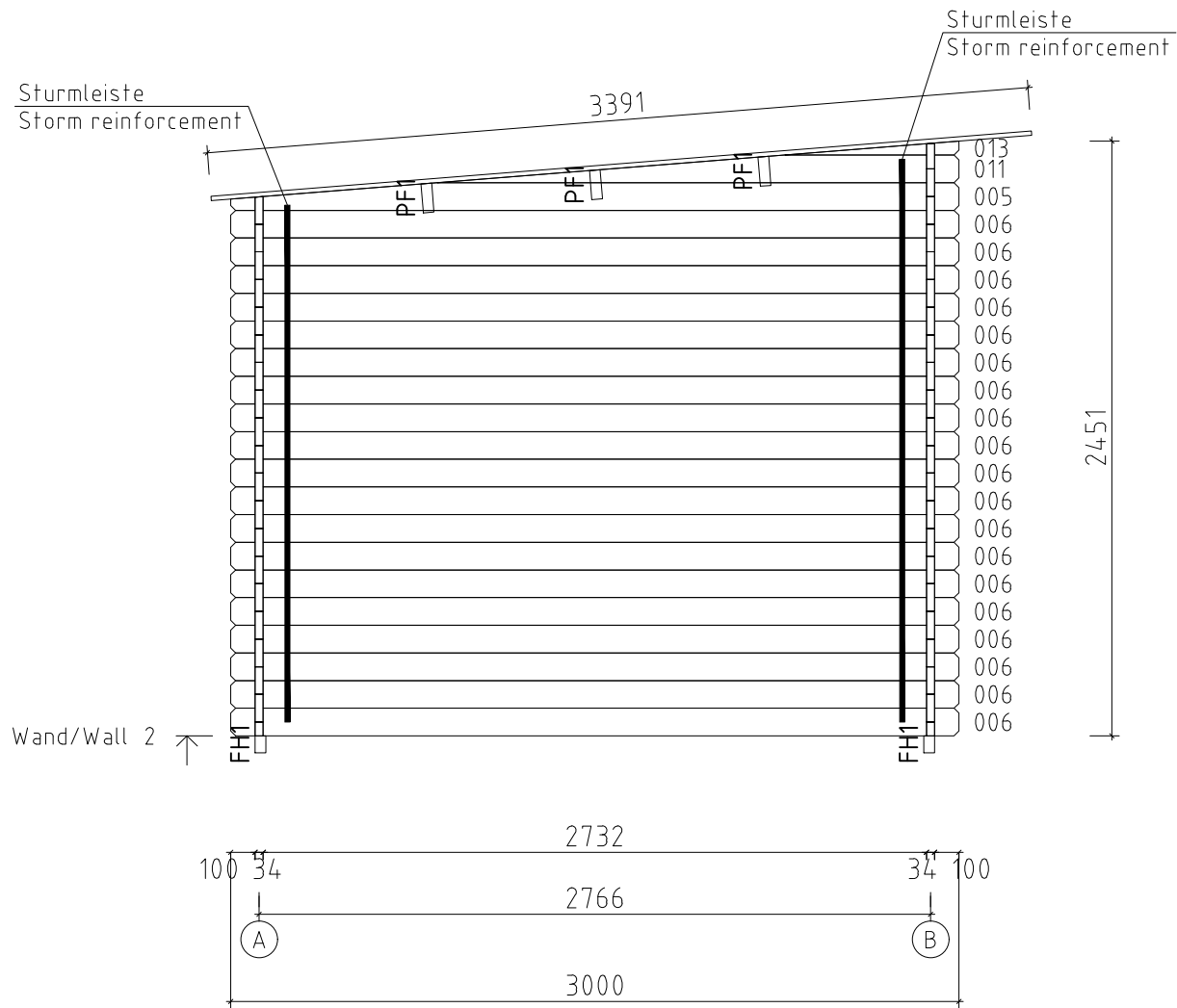

Name	Lillian TP 4x3 300x400_34		
Zeichnung/Drawing	WAND/WALL 2	VS34_Lillian TP 4x3	
Profil/Profile	3.4x11.4	Maßstab/Scale	1:30
		Druck auf/ Print on	A4
		Datum/Date	18.02.2025